

Harvester Operation and Service Manual

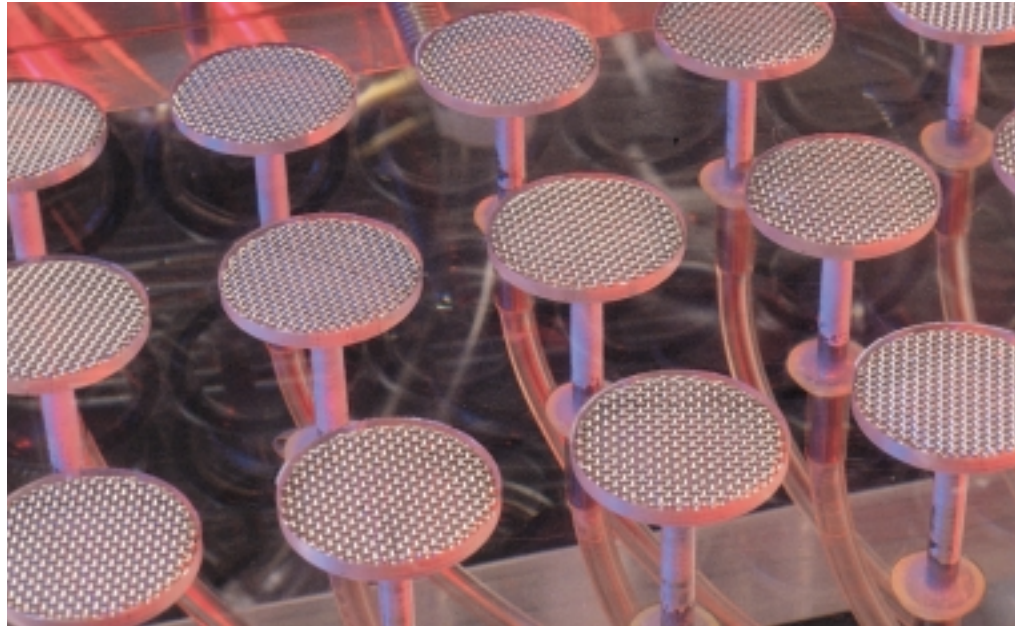

<i>Before Setting Up Your Harvester</i>	3
<i>Parts List</i>	3
<i>Requirements</i>	3
<i>Harvester Installation</i>	4
<i>Wash Installation</i>	5
<i>Vacuum Installation</i>	6
<i>Operation</i>	8
<i>Adjustments</i>	10
<i>Options</i>	15
<i>Tubing</i>	20
<i>General Maintenance</i>	22
<i>Tips for Using Your Harvester</i>	23
<i>Filter Paper</i>	24
<i>Warranty Information</i>	25

Thank You

Brandel would like to thank you for your purchase.

Your new Harvester is the product of more than 25 years of ongoing refinement, designed to provide you with many years of use and satisfaction with a minimum of maintenance. We are confident that you will find your Harvester to be one of the best pieces of equipment available today, and for years to come.

If you have any questions or suggestions, now or in the future, please do not hesitate to contact us.

About this Manual

Copies of this manual are posted on the Brandel web site in Adobe Acrobat® (pdf) format. If you misplace your original or find the digital form more convenient, please feel free to download a copy and save it on your computer for future onscreen reference or printing.

We strongly encourage you to read this manual carefully as you unpack and assemble your Harvester. The time you spend doing so will help you to better understand its workings and capabilities, and will minimize the amount of time spent on installation.

Please refer to the General Maintenance section on page 22 for suggestions on keeping your Harvester in optimal condition.

On page 23 you will find Helpful Tips and answers to frequently asked questions.

BRANDEL, Inc.
8561 Atlas Drive
Gaithersburg, MD 20877

E-mail: sales@brandel.com
<http://www.brandel.com>

Telephone: 800-948-6506
Fax: 301-869-5570

The systems and products displayed in this manual are for illustration purposes only. Due to technical advances, actual products may not be exactly as illustrated.

Before Setting Up Your Harvester

Remove all packing materials and inspect for shipping damage!

If there is any damage, please report the nature of the damage to your local branch of the shipping company who delivered your Harvester. If necessary, contact Brandel for replacement parts.

Connect handle into "on-off" valve on the bottom, right of harvester. This handle was disconnected for shipping purposes.

Your Shipment Includes

1 each	Harvester
1 each	Power Cord
1 each	4 litre Wash Bottle; CH-100
1 each	Test Tube Rack (if harvesting from test tubes); CH-111 (standard) or CH-112
1 each	4 litre Collection Reservoir; CH-300
1 each	Wash Pump; CH-600
1 each	Solenoid Bay; CH-200
1 each	Vacuum Gauge; CH-900
1 each	On-Off Valve; CH-450
1 box	Whatman Filter Paper
1 piece	Wash Tubing (for wash bottle to wash pump), connected to Wash Bottle
1 piece	Wash Tubing (for wash pump to solenoid), connected to Wash Pump
1 each	Flow Regulator Valve; CH-601
1 pkg.	Flow Adjustment Wrenches
1 piece	Vacuum Hose (for trap bottle to vacuum source),
1 piece	Vacuum Hose (for trap bottle to on-off valve), connected to Collection Reservoir
3 each	3 amp Fuse
1 each	Operation and Service Manual

Additional items will be included if they were ordered with the Harvester.

Requirements For Use

- Standard electric wall outlet (110V or 220V depending on your region)
- Vacuum source (house) or vacuum pump. Vacuum source must be equivalent to 20" of 3 Hg. at 3.5 cf./min.
- Please Note: A faucet aspirator will *not* provide sufficient vacuum for the Harvester to perform properly.
- Brandel offers a full line of vacuum pumps which are ideal for use with your Harvester. Please contact Brandel for ordering information, or visit our Web site to learn more.

BRANDEL, Inc.
8561 Atlas Drive
Gaithersburg, MD 20877
Telephone: 800-948-6506
Fax: 301-869-5570
E-mail: sales@brandel.com
<http://www.brandel.com>

Installing Your Harvester

Please Note: The power switch, located on the side of the solenoid box, must be turned on in order for the Harvester to be activated. Brandel strongly suggests that this switch be turned off at the end of each day or harvesting session. Turning this switch off will remove voltage from all components.

In the event of a power surge, or if the power switch is inoperative, replace the fuse (extra 3 amp fuses have been supplied) which is located next to the power switch on the solenoid box.

1. Electrical Installation

Connect the male plug from the harvesting probe switch to the matching outlet on the back of the solenoid chassis box.

Plug the female end of the Harvester power cord into the EC 320 connector located on the back of the solenoid, plug the male end of the cord into a standard wall outlet (110V or 220V depending on your region). Depressing the wash switch on the right side of the harvesting probe should cause a clicking sound from the solenoid. Plug the cord from the wash pump into the remaining outlet on the back of the solenoid chassis box.

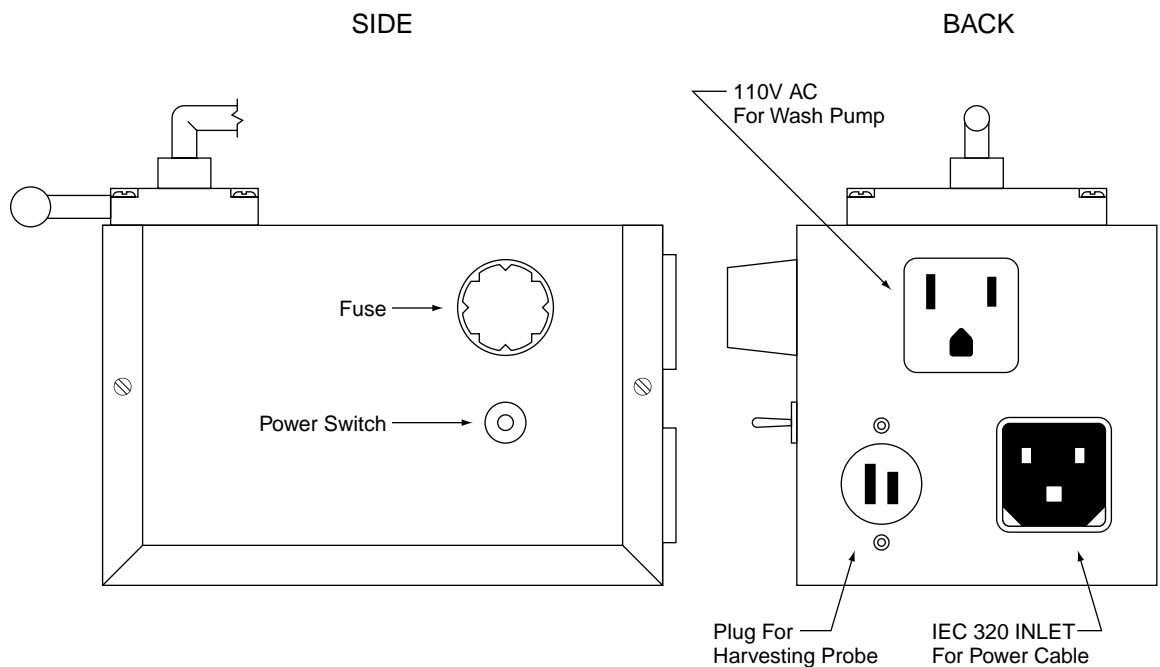

110V SOLENOID CHASSIS BOX

2. Wash Installation

Connect the tubing from the wash media bottle to the open inlet connector on the wash pump.

Confirm that the tubing from the outlet connector of the wash pump to the inlet (open) connector on the solenoid is in place. This tubing was connected to the wash pump prior to shipment.

Fill the wash media bottle with the desired buffer. With the wash pump electrically unplugged but with all tubing connected, elevate the wash bottle above the level of the wash media pump. Depress the wash switch on the harvesting probe. Allow buffer solution to flow through the wash pump until all air is removed from the pump. Outlet tubing from the wash pump will begin to fill with wash media. Plug the wash pump electrical cord into the back of the solenoid. Finally, place the wash media bottle at the desired level (above the wash pump).

CAUTIONS

- Do not run pump dry.
- Do not tighten top on wash media bottle.
- Do not place wash media bottle lower than the wash pump.
- If it becomes necessary at some point to dislodge air bubbles from inside the wash pump, re-prime the wash pump using the same procedure described above.

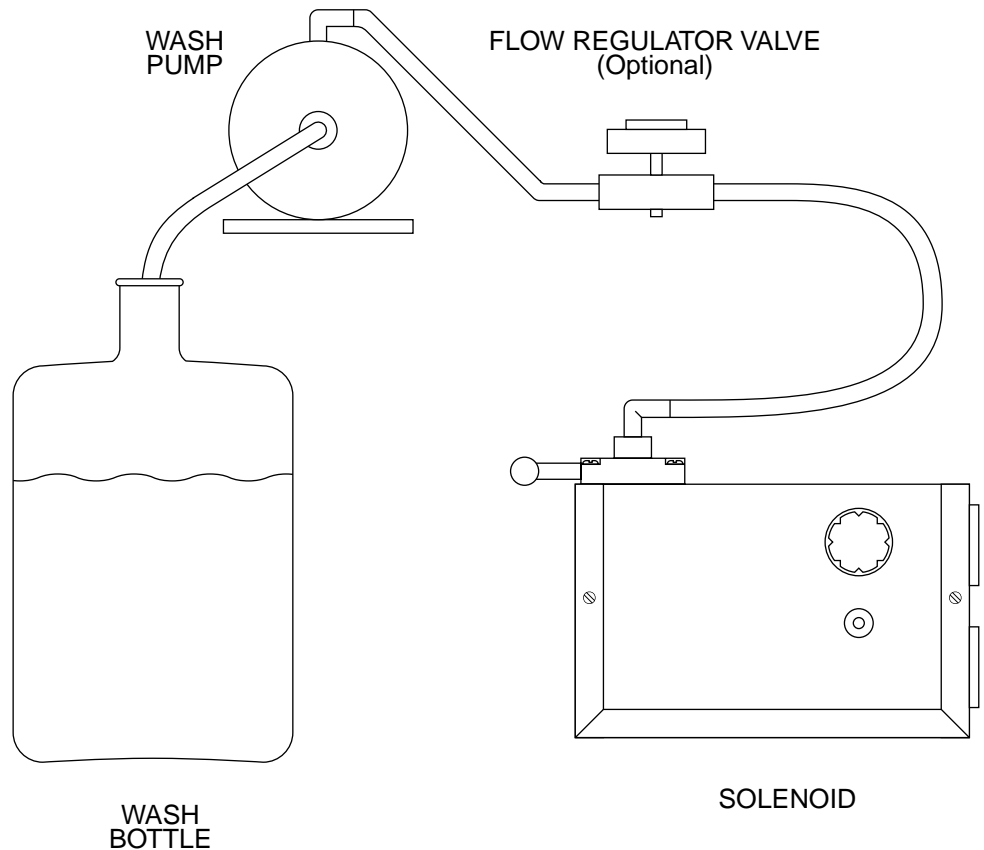

3. Vacuum Installation

This section only applies to machines without the programmable controller (on page 15).

The on-off valve, located on the front, right corner of the base plate, eliminates the need for turning on/off your vacuum after each harvesting procedure. Prior to harvesting, the vacuum hose, labeled "connect to on/off valve" on the collection reservoir should have been connected to the open plastic connector of the on-off valve. Turning the handle to the "Harvest" position (Fig. A) will open your vacuum to the Harvester. Turning the handle completely inward to the "Purge" position (Fig. B) will aspirate your buffer solution back towards the wash manifold and prevent any drippage from the harvesting probe when the Harvester is not in use. The "off" position (middle position of valve) will completely shut-down the vacuum to the Harvester and allow for filter paper removal.

A. COMMON COLLECTION OF FILTRATE

Install the tubing on the collection reservoir (labeled "connect to vacuum source") to a house vacuum line (vacuum source must be equivalent to 20" of 3 Hg. at 3.5 cf./min.) or the vacuum pump. Install the tubing (labeled "connect to on-off valve") to the open 3/8" hose adapter on the on-off valve.

Brandel strongly suggests placing a second collection reservoir in the line going to your vacuum source to prevent water vapor from entering your system.

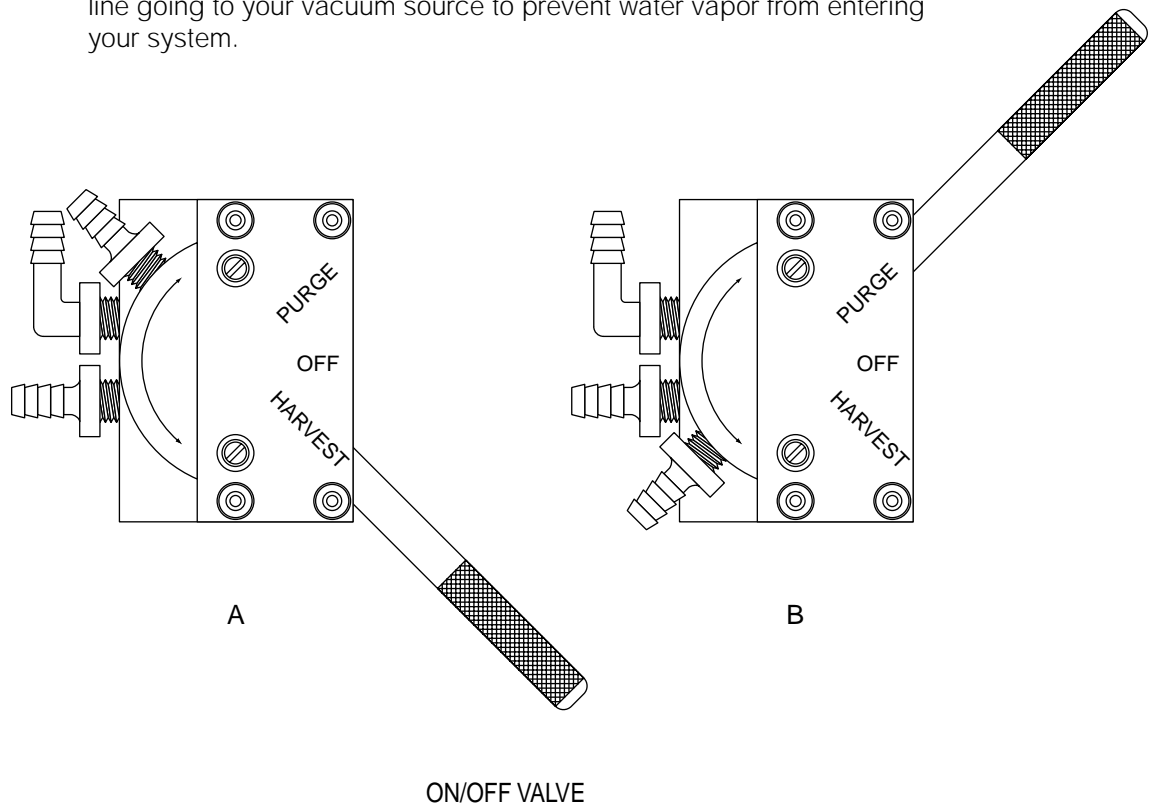

B. INDIVIDUAL COLLECTION OF FILTRATE

When using the individual collection box, remove the four wing nuts from the interchangeable block(s) (plastic hose adapter is located in the middle of the block) located underneath the top plate on the back, right corner and replace with the interchangeable block(s), which is tubed to the individual collection box.

Make certain that the dowel pins located on the interchangeable block(s) fit into the corresponding hole of the matching interchangeable block(s).

Remove the vacuum hose which is connected to your on-off vacuum valve on the base of the Harvester. Place the vacuum hose coming from the individual collection box, onto the same on-off valve connector.

When using your individual collection box, the "BRANDEL" engraving on the lid of the individual collection box should face towards the front of the Harvester. The row closest to the "front" of the individual collection box corresponds with the first row on your filter block. When finished collecting your individual filtrates, open the three-way valve, (located on the vacuum hose coming from the individual collection box), to release the vacuum from inside of the individual collection box.

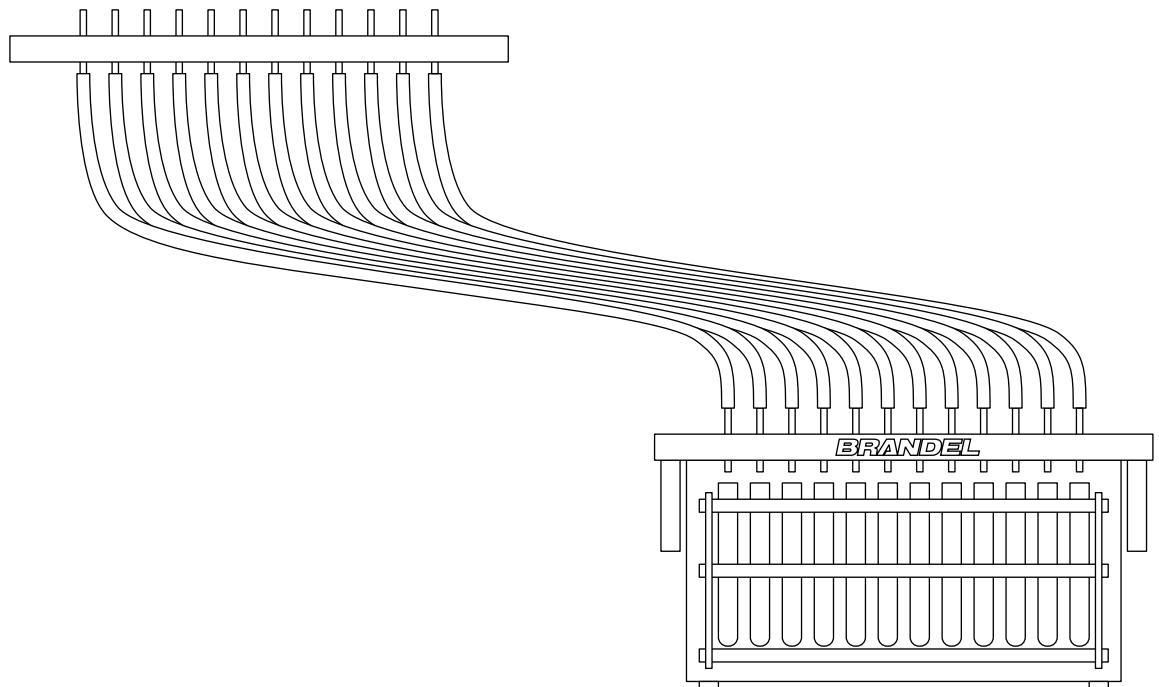

Operation of Your Harvester

1. Microtitre Tray & Test Tube Rack Holder

The tray on the front of the harvester is for securing your micro-titre plate or test tube rack in place while harvesting. To put the tray into its functioning position, lift the front of the tray until the dowel pins are aligned with the grooves in the tray holders (which hold the tray on the top plate). Push the tray straight back until the dowel pins enter and clear the groove, then push down *softly* until the plate stops.

To disengage the tray, lift the front of the tray until you can see the dowel pins in the center of the groove. Pull the tray forward, clearing the dowel pins from inside the holders. Continue to pull the tray forward until it comes to a stop, then lower the front of the tray. The tray should now be hanging down and out of the way, in front of the Harvester.

2. Proper Aspiration

Make certain that the aspiration needles in the harvesting probe are not touching the bottom of the wells when aspirating. Hold the probe slightly above the bottom of the wells in order to prevent the bottom of the aspiration needles from sealing against the bottom of the wells. If the aspiration needles are sealing, individual wells may overflow.

Make certain that with a strip of filter paper inside the filtering block, your vacuum gauge is reading a minimum of 18" Hg. while aspirating. A vacuum reading of less than 18" Hg. may lead to poor aspiration, and individual wells overflowing.

When the Harvester is not in use, keep the filter block closed, but *not latched*, to prevent unnecessary strain on the o-rings.

When using a microtitre plate configuration, make certain that the two-way valve on the black wash pump has been adjusted to prevent excessive delivery into each individual well.

Make certain that the handle on the on-off vacuum valve is fully turned to the "HARVEST" position in order to ensure proper aspiration from the harvesting probe.

If you are using the tray on the front of the Harvester, and are harvesting (especially from test tubes), make certain that while the harvesting probe is held off the bottom of the wells that the tubing is not being crimped on the back side of the harvesting probe. Holding the probe near the latches on the filter block (at the back edge of the tray) and very high off the bottom of the wells (5" or more) may cause a decrease in aspiration.

3. Proper Delivery

Make certain that the handle on the on-off vacuum valve is fully turned to the "HARVEST" position and secured in place to allow for delivery of buffer to the harvesting probe. If the handle is not turned to this position your buffer solution will go directly into your collection flask.

Make certain that the wash pump has been completely primed (see page 5).

If you are using a two-way valve on the black wash pump make certain that the valve is *not* closed so far as to prevent an adequate amount of delivery into each individual well.

4. Securing the Harvesting Probe After Harvesting

When not in use, the harvesting probe should be inverted and the two metal rods should be placed into the two holes in the filter block. Invert the probe such that when facing the front of the Harvester the wash switch cap on the harvesting probe is located on the right side.

Prior to placing the two metal rods of the harvesting probe into the corresponding holes on the top half of the filter block, pull back on the tygon tubing which is above the filter block. Pulling this tubing towards the back of the Harvester will allow the harvesting probe rests (two metal rods) to fit better and remain seated in the filter block.

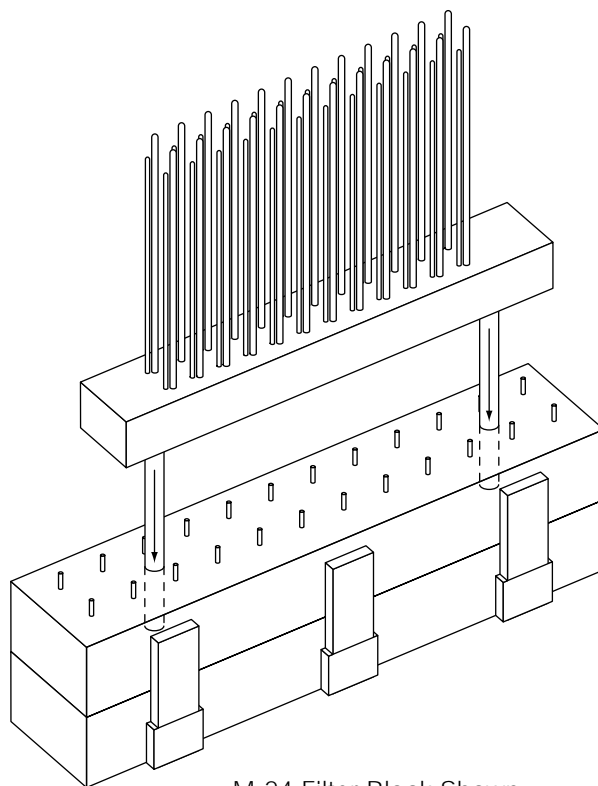

M-24 Filter Block Shown

Making Adjustments to Your Harvester

1. Microtitre Tray & Test Tube Rack Holder

The two white plastic pieces on the tray and test tube rack holder have been slotted to allow adjustment of how tightly the plate/test tube rack is held in place while harvesting. To adjust the fit on the tray/test tube rack, loosen the two screws on the two plastic pieces. Slide the pieces in the necessary direction until the proper fit is obtained. Re-tighten the two screws. *Do not over-tighten the screws on the two plastic pieces.*

2. Wash Fluid Pressure

On Harvesters working from micro-titre plates the flow regulator valve between the wash pump and the solenoid has been pre-adjusted to prevent an overflow in the wells. Harvesters working only from test tubes have been set to achieve the maximum flow possible. However, if a change in flow rate is desired follow the procedure below.

If a decrease in flow is desired (and the harvester is working from test tubes) substitute the additional hose (supplied with the flow regulator valve) which was labeled and packed in the accessory box, for the hose which is currently between the wash pump and the solenoid.

Obtain a minimum reading of 18" of Hg. on the Harvester vacuum gauge. Place the harvesting probe in the plate or test tubes and depress the switch.

Adjust the two-way valve such that the flow washes all wells sufficiently but does not overflow individual wells.

Caution: Do not turn the two-way valve so far as to allow only a drippage of wash fluid to be delivered to any well.

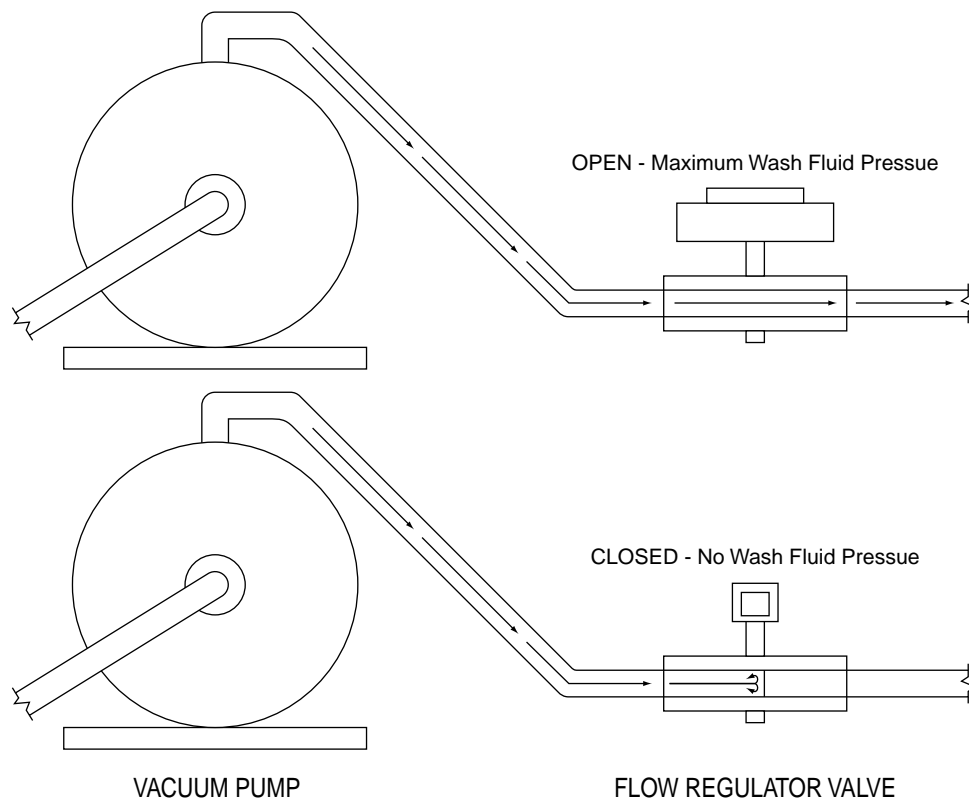

3. Individual Flow Adjustment for Each Well

Although this procedure is detailed below, it should never need to be done!
Please contact Brandel before attempting individual flow adjustment!

The flow of each channel has been adjusted such that all channels deliver an equal amount of wash solution. Usually these channels never need to be adjusted. However, if the system requires some further adjustment, adjust the fastest channel such that it delivers the same rate of wash solution as the slowest channel.

WHEN USING THE COLLECTION MANIFOLD...

1. Place the probes into individual test tubes or wells. Depress the wash switch on the harvesting probe until the test tubes are approximately 3/4 full.
2. On the flow adjustment bar (secures tubing above harvesting probe) are individual set screws that adjust the flow of each individual delivery needle. To *decrease* the flow, turn the corresponding set screw *in* approximately 1/2 turn, (or less) if a very small change is needed. An allen wrench is supplied.
3. Repeat first step.

WHEN USING THE INDIVIDUAL COLLECTION FILTRATE BOX...

1. Depress the wash switch on the harvesting probe and allow wash media to aspirate until the collection tubes in the collection box are approximately 3/4 full.
2. On the flow adjustment bar (secures tubing above harvesting probe) are individual set screws that adjust the flow of each individual delivery needle. To *decrease* the flow, turn the corresponding set screw *in* approximately 1/2 turn, (or less) if a very small change is needed. An allen wrench is supplied.
3. Repeat first step.

4. O-Ring Pressure Adjustment

Proper scoring is being obtained if all o-rings are making a uniform circular pattern on the filter paper.

The amount of pressure applied by the "o-rings" was adjusted for proper pressure prior to shipping. However, if a change in the amount of pressure is desired follow the procedure stated on the following page.

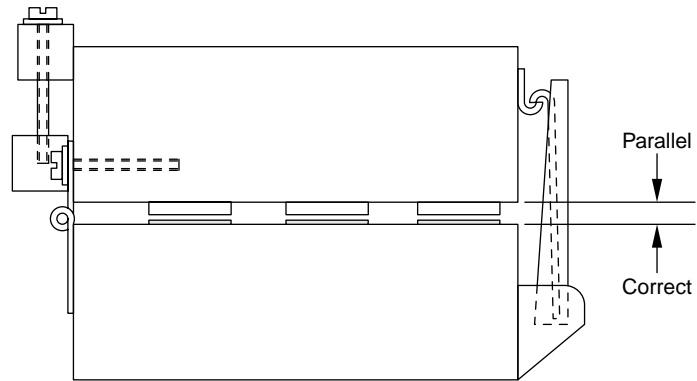

CORRECT

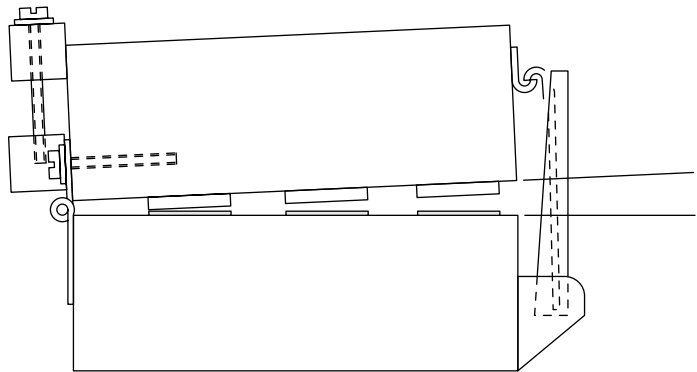

WRONG

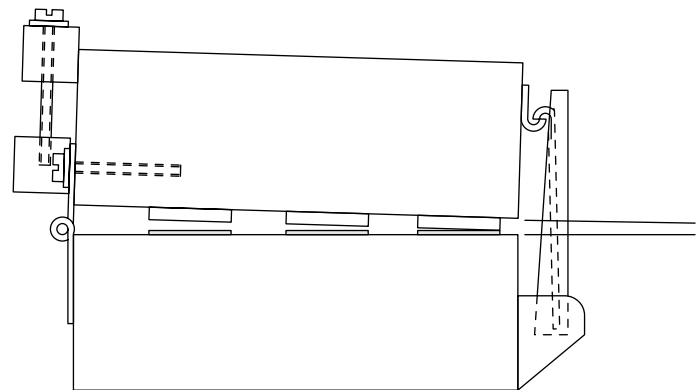

WRONG

5. Adjusting Pressure on the Front Half of the Filter Block

Adjust the three (or four) latches on the front of the filter block. Turning the latches clockwise will increase the amount of pressure applied by the front half of the filter block. Turning the latches counter-clockwise will decrease the amount of pressure.

Warning: Only turn the latches one full rotation at a time before re-testing the pressure being applied to the front half of the filter block.

6. Adjusting Pressure on the Back Half of the Filter Block

Release the three (or four) latches on the front of the filter block and loosen the six "top screws" on the top half of the filter block hinge.

Turning the "adjustment screws" clockwise will increase the amount of pressure being applied by the back half of the filter block. Turning the "adjustment screws" counter-clockwise will decrease the amount of pressure being applied by the back half of the filter block.

Warning: Only turn each "adjustment screw" 1/2 rotation before re-testing the pressure being applied to the back half of the filter block.

Prior to re-testing the back pressure of the filter block make certain the six "top screws" have been re-tightened.

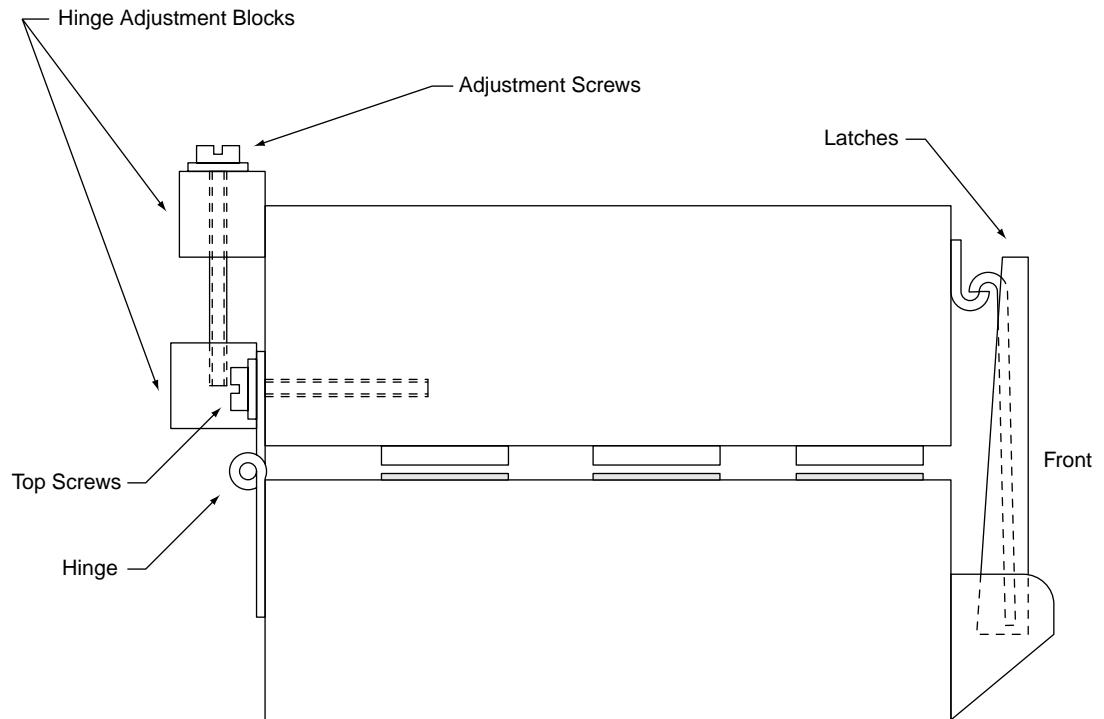

SIDE VIEW OF FILTER BLOCK

7. Aspiration

Caution: Release the three (or four) latches on the block when the Harvester is not in use to prevent any "flattening" of the o-rings.

Release the latches on the filter block and raise the top half of the filter block. Place one strip of filter paper over the metal screens on the bottom half of the filter block. The filter paper should be wet to prevent leakage around the edges. Close the filter block, making certain all o-rings are completely inside the strip of filter paper. Fasten the latches to the strikes on the top half of the filter block. Turn on the vacuum source, or open on-off vacuum valve if vacuum source is already on. Check the vacuum gauge indication to make certain a reading of 18" of Hg. or more is being obtained.

If the vacuum gauge does not read at least 18" of Hg. place the harvesting probe into microtitre plates or test tubes (depending on type of probe being used) and repeatedly depress wash switch on probe until a reading of 18" of Hg. is obtained.

If a reading of 18" of Hg. is still not obtained make certain that all o-rings are "scoring" the paper sufficiently and that all tubes in the system are secured.

Please contact Brandel if these steps are not sufficient to obtain proper vacuum, as the problem may be an insufficient vacuum source.

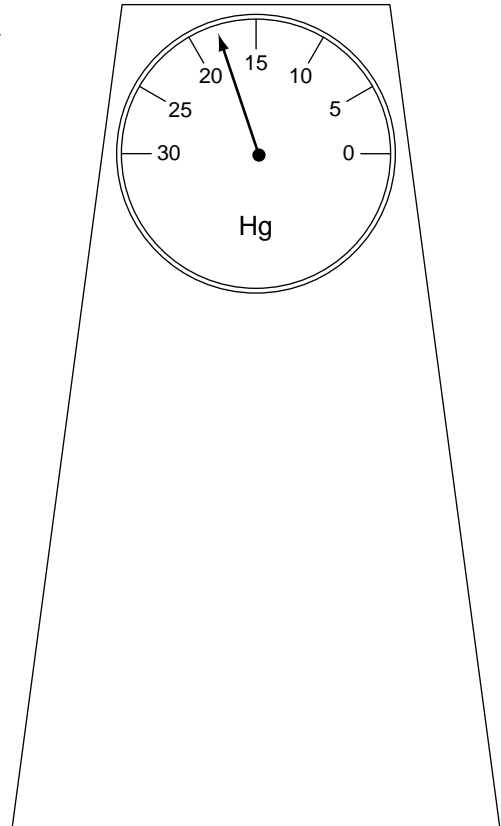

VACUUM GAUGE

Optional Components for Your Harvester

1. Remote Programmable Controller

For detailed instructions on using the Remote Programmable Controller, (if ordered) please consult the Remote Programmable Controller Manual.

To connect the remote programmable controller to your Harvester, first plug the Harvester switch cable into the "Harvester Switch" jack on the back of the controller.

Next, plug the timer box into a standard wall outlet.

It is strongly recommended that the Harvester power cord be plugged into CH #2 and the was pump be plugged into CH #1. Using these two outlets will enable the user to have the manual wash available at any time.

2. Large-Capacity Reservoir with Auto-Drain

There are three main components that make up the auto-drain system.

1. Large-Capacity Collection Reservoir
2. Auto-Drain Controller
3. Auto-Drain Pump

Notice that on all the tubes attached to the reservoir are labels specifying where each tubing connection should be made.

1. Connect the tubing labeled "Drain Reservoir" to the drain on the plexiglass reservoir.
2. Connect the tubing labeled "Connect to Drain Pump" to the auto-drain pump on the horizontal fitting.
3. Connect the tubing labeled "Connect to Collection Reservoir" coming from the fitting on the auto-drain box to the top of the collection reservoir.
4. Attach the tubing labeled "Connect to Vacuum Source" to a vacuum supply.
5. The tubing attached to the drain pump that has no label goes to your final drain receptacle.

Three electrical connections must also be made to the auto-drain box.

1. Connect the power cord to the auto-drain box
2. Connect the collection reservoir sensor to the auto-drain box.
3. Connect the auto-drain pump to the auto-drain controller

The included keys are to be used to switch the auto-drain box to either automatic or manual mode. In manual mode, the collection reservoir can only be drained by depressing the black button. When the collection reservoir is filled to the upper sensor, a red, flashing light is activated and an audible alarm is sounded (if selected). In automatic mode, the collection reservoir empties when filled to the top of the sensor. When harvesting in this mode, it is critical that the drain tubing from the pump is placed in an emptying receptacle.

In either mode, the collection reservoir will empty only to the point of the bottom of the sensor. If more drainage is required, depress and continually hold the black manual drain button. Care must be taken so as not to completely empty the bottle and the pump as this will necessitate a repriming of the pump.

3. Hot-Cold Collection Valve

The hot-cold wash valve is designed to provide the ability for separate collection of radioactive and non-radioactive waste.

If the hot-cold wash valve was not originally ordered with the Harvester and installed by Brandel, use the two extra holes located on the left side of the base plate of the Harvester for mounting the hot-cold wash valve.

When using the hot-cold wash valve connect the vinyl tubes on the collection reservoir bottles (labeled "connect to valve") to the two remaining connectors on the bottom half of the hot-cold wash valve. Connect the tube on the plastic "Y" (labeled "connect to vacuum source") to your vacuum source. Connect the two remaining tubes on the plastic "Y" (labeled "connect to trap bottles") to the collection bottles.

When using and disposing of non-radioactive waste turn the top half of the valve (using the handle installed in the valve) in the direction of "cold" port. Turning the valve clockwise (as far as possible) will allow for the use and disposal of radioactive waste into the "hot" collection reservoir bottle.

To disassemble the hot-cold wash valve remove the two screws located on the bottom side of the base plate which are securing the valve. Remove the four caphead screws on the top half of the valve cover, counter-clockwise, thus removing the white colored valve housing on the top of the valve. Remove the large cap screw inside the top half of the valve such that both pieces will come apart. Use your fingers to remove the o-rings. Do not use a sharp instrument to remove the o-rings.

To assemble, reverse the above process. When tightening the cap screw make certain that the o-rings are sealing against the bottom of the top half of the valve. Check the turning motion for ease of movement.

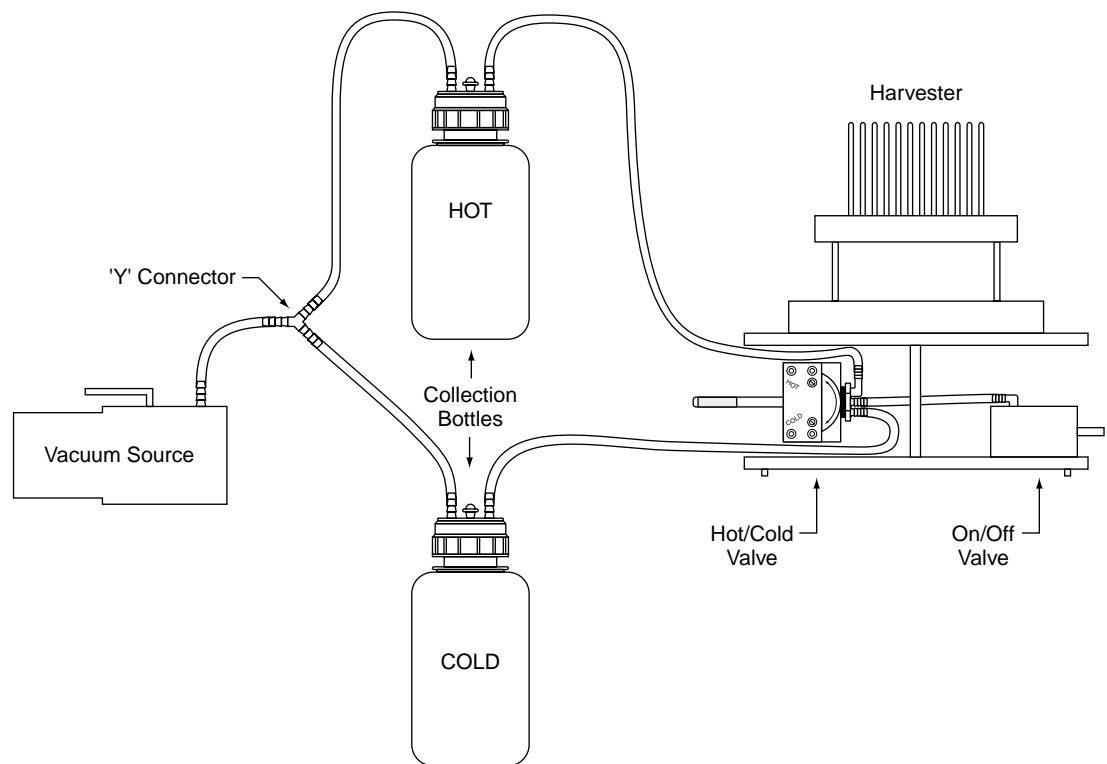

Options

4. Wash Timer

The wash timer assures that the same volume of wash solution is delivered to your wells each time.

A. INSTALLATION

Place the wash timer next to the Harvester in a convenient location.

Remove the male plug from the end of the cord that is marked "TO SWITCH." When using the wash timer, place this male plug into the back of the solenoid box on the back of the Harvester. This will allow the timer to effectively operate the Harvester.

Plug the female plug marked "TO SWITCH" into the male plug coming from the probe cord of the Harvester.

Plug the power cord of the Harvester into the back of the wash timer plug marked "TO HARVESTER."

Plug the power cord of the timer marked "TO 110VAC" into a standard wall outlet (110V or 220V depending on your region).

B. OPERATION

Manual mode allows the operator to determine the amount of delivered wash solution each time. The timer does not need to be disconnected from the Harvester for manual operation.

Automatic mode allows delivery of an identical amount of wash solution to all wells each time. In Automatic mode, the delivery amount can be adjusted by turning the knob on top of the wash timer.

To engage the wash timer, position the harvesting probe into the wells and hold down the switch on the probe. Wash delivery will automatically discontinue at the time interval selected.

If the delivery switch is released prior the end of the desired time cycle, delivery will discontinue immediately and the timer will reset itself.

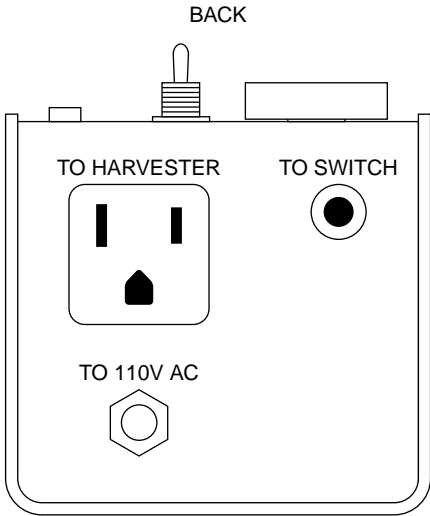
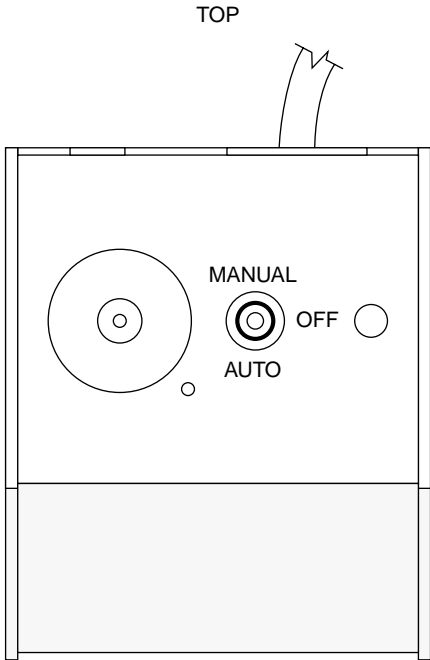

110V WASH TIMER

C. DELIVERY TIME

The timer has an almost infinite amount of settings, which will allow for a greater time period than the Harvester would ever need. For the purposes of this manual we only consider the reasonable settings (amount of time) that could be used with the Harvester.

Upon shipping, the timer was set to run from 1-10 seconds and can be adjusted to the preferred setting by turning the dial. However, if a period of time longer than ten seconds is desired, please refer to the table shown below to obtain the proper setting.

Turning the left screw adjusts the Time Selector: this adjustment gives you four choices that begin with times of: 0.5 or 1.0 or 2.0 or 10.0

Turning the right screw adjusts the Time Unit Display: this adjustment gives you a choice of either seconds or minutes

When the time selector is adjusted to show the numbers in the far left column and the dial is set at the number on the second column from the left, and the time unit display is set to seconds, the amount of time (in seconds) the timer will operate is shown in the third column from the left.

When the time selector is adjusted to show the numbers in the far left column, and the dial is set at the number on the second column from the left, and the time unit display is set to minutes, the amount of time (in seconds) the timer will operate is shown in the far right column.

TIMER FACE

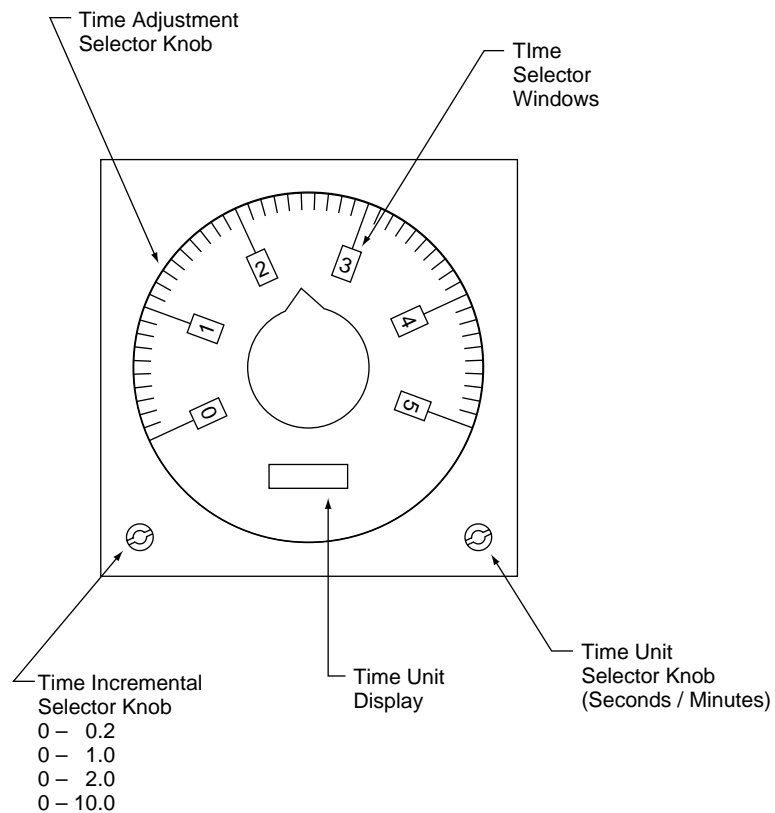

5. Multi-Wash Systems

(for additional washes)

A complete wash system (if ordered) consists of:

- 1 each Wash Pump (optional)
- 1 each Wash Media Bottle
- 1 each Multi-Wash Table with Switch
- 1 each Wash Trough (mounted onto multi-wash table)
- 1 each Solenoid (mounted onto multi-wash table)
- 1 each 2-Way Flow Regulator Valve
- 1 each Necessary Tubing

Only part of the system may have been ordered with your Harvester. All instructions should be modified accordingly.

A. CONNECTIONS AND INSTALLATION

1. Connect the tubing from the multi-wash buffer bottle, labeled "connect to multi-wash pump," to the wash pump.
2. Connect the tubing labeled "connect to multi-wash solenoid" to the white fitting of the solenoid on the multi-wash table.
3. Prime the multi-wash pump in the same manner as priming the wash pump for the harvester (see page 3).
4. Place the multi-wash table near the Harvester in such a manner that the wash trough is close to the front edge of the Harvester.
5. The flow regulator valve has already been pre-set. If a change in flow is desired turn the handle on the flow regulator valve. (Turning the handle parallel to the valve increases the flow, turning the handle perpendicular decreases the flow).
6. Plug the multi-wash pump plug into the back of the multi-wash solenoid.
7. Plug the multi-wash switch (located on the multi-wash table) into the back of the multi-wash solenoid.
8. Plug the multi-wash solenoid into a standard wall outlet (110V or 220V depending on your region).

The wash is fed into the trough by the depression of its corresponding switch located on the multi-wash table. (If a wash pump was purchased with the multi-wash system, the two-way valve on the tubing from the wash pump can be adjusted to regulate the rate of flow into the wash trough). With vacuum pressure applied and after filling the wash trough, place the harvesting probe into the wash trough. The harvesting probe will aspirate the additional wash fluid from the trough onto the filter paper. Additional washings may be accomplished by repeating this procedure.

Tubing for 18-Sample Harvesters

1. Modification for Interchangeable Harvesting Probe

All BRANDEL Harvesters are pre-equipped for interchangeable harvesting probes.

2. Mounting Interchangeable Harvesting Probes

The receptacle for the interchangeable harvesting probe is mounted onto the three holes on the left side of the top filter block. The receptacle plug (one receptacle is included for each probe) for the interchangeable harvesting probe is mounted on top of the receptacle. Mount the receptacle such that the tubing clip is facing towards the inside of the Harvester. Push down gently on the receptacle with a rocking motion until the receptacle is resting on top of the red rubber gasket. *Do not bend* any of the needles in the plug. Place wing nuts onto the four threaded posts and tighten until they just start applying pressure to the red gasket. Tighten wing nuts alternately, one turn at a time, until moderate pressure is applied to ensure no vacuum leakage.

Caution: Do not tighten wing nuts excessively such that needles in the receptacle mount and needles in the receptacle plug touch.

A new wash manifold must also be substituted when changing harvesting probes. Remove the four wing nuts. Make certain the "o-ring" is still in place and not resting on top of the four metal nuts. Place the second wash manifold on (make certain "o-ring" is outside all needles of wash manifold) and gently tighten the wing nuts until they just start applying pressure on the "o-ring". Next, tighten the wing nuts, alternately, one turn at a time, until moderate pressure is applied to the "o-ring".

Caution: Do not tighten wing nuts excessively.

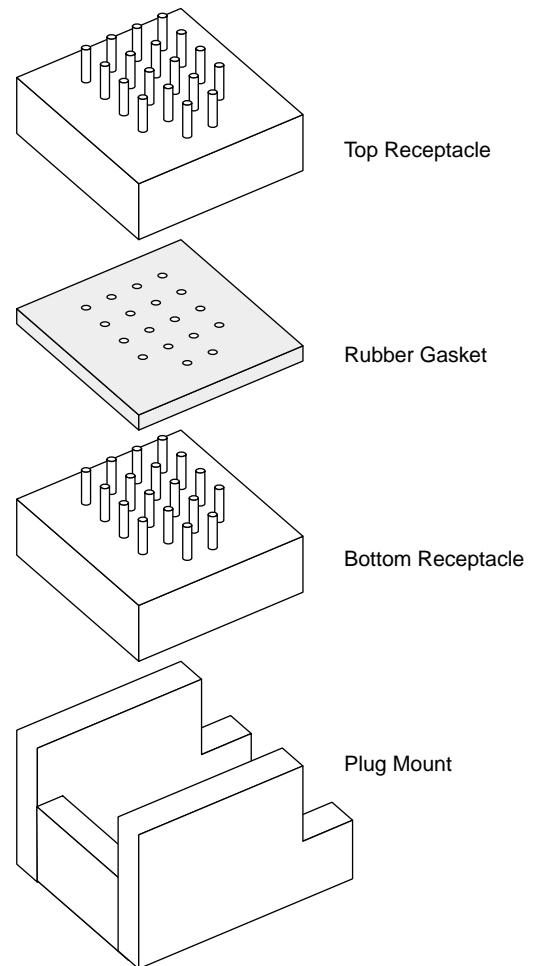

3. Tubing Diagram for the 18-Sample Harvester

Refer to the diagram below for tubing information.

The tubing from the top of the filter block should run to the receptacle mount and correspond with each number, (i.e., # 1 on the filter block to # 1 on the receptacle, #2 to #2, etc.). Tubing from the receptacle plug should then correspond with the harvesting probe in the same manner.

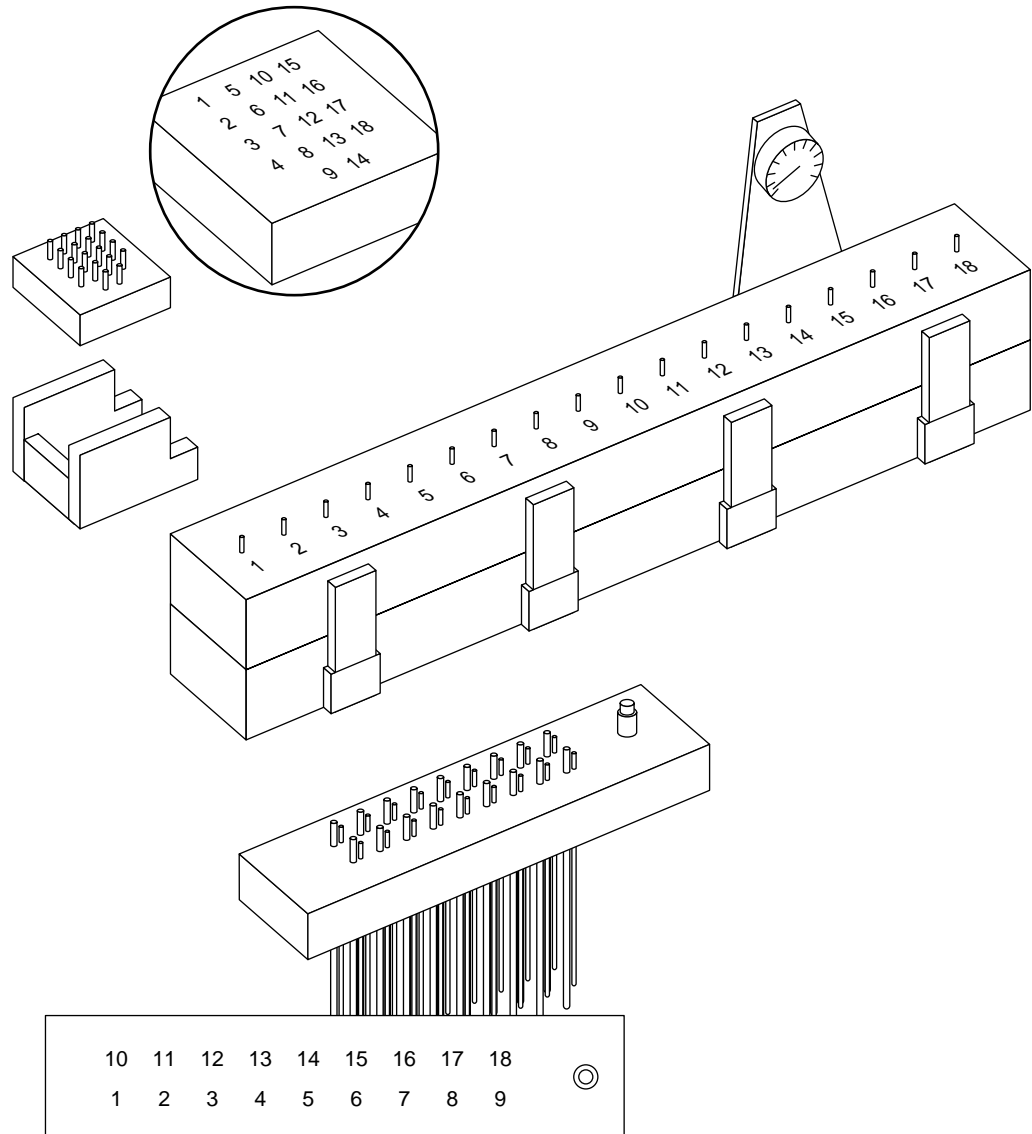

Tubing

General Maintenance

Your Brandel Harvester has been designed for relatively maintenance free service. However, certain steps should be taken to provide optimal service from your Harvester. The steps detailed below will not only keep your Harvester aesthetically clean, but also provide for uniform delivery and aspiration – even after years of use.

After shipment, and/or continued use of the Harvester the white plastic permanent ties binding together the clear plastic tubing may need to be tightened. *However, caution should be exercised so as not to pinch shut any tubes.* Normally, pushing down on the square part (head) of the plastic permanent tie for one or two notches is sufficient to secure the tubes into a firmly held bundle.

All outside lucite parts can be cleaned with alcohol, Windex or any other cleaning agent of your choice which is not abrasive or a solvent to lucite.

After a few hours of occasional use or continued use over the course of a day the tubing should be rinsed out with deionized water or a solution of 30% alcohol. After a period of time a chemical solution can also be used to prevent or eliminate any counts from remaining inside the tubing.

A soft bristled brush (such as a toothbrush) may be used with water or alcohol to clean the stainless steel filter screens.

After prolonged use over years you may wish Brandel to provide replacement tubing, o-rings or screens.

Brandel can provide tubing in coils (you re-tube the lines to be changed) or all tubes coming to and going from harvesting probe pre-cut with a new wash manifold (for your convenience), labeled and ready to be installed. This tubing can also be pre-cut for your collection manifold (new collection manifold, for your convenience), labeled and ready to be installed.

All o-rings are supplied with epoxy for replacement.

Your Harvester's stainless steel filter screens have been pressed into your filter block. Brandel will supply the replacement screens for you to fit back into place. Simply remove the old screen; pry out with a suitable object, and place the new screens into place.

Tips for Using Your Harvester

1. Proper Aspiration

Make certain that the aspiration needles in the harvesting probe are not sitting on the bottom of the wells when aspirating. Hold the probe slightly above the bottom of the wells in order to prevent the bottom of the aspiration needles from sealing against the bottom of the wells. If the aspiration needles of the harvesting probe are sealing against the bottom of the wells, certain wells may overflow.

Make certain that with a strip of filter paper inside the filtering block your vacuum gauge is reading a minimum of 18" Hg. while aspirating. A vacuum reading of less than 18" Hg. may lead to poor aspiration, and individual wells overflowing.

While not using the Harvester, the filter block should be closed but *not latched*, to prevent unnecessary strain on the o-rings.

Make certain that if you are using a microtitre plate configuration you have adjusted the two way valve on the black wash pump to prevent an excessive amount of delivery into each individual well.

Make certain that the handle on the on-off vacuum valve is fully turned to the "HARVEST" position in order to ensure proper aspiration from the harvesting probe.

If you are using the tray on the front of the Harvester, and are harvesting (especially from test tubes), make certain that while the harvesting probe is held off the bottom of the wells that the tubing is not being crimped on the back side of the harvesting probe. Holding the probe near the latches on the filter block (in other words, at the back edge of the tray) *and* very high off the bottom of the wells (5" or more) *may* cause a decrease in the aspiration.

2. Proper Delivery

Make certain that the handle on the on-off vacuum valve is fully turned to the "HARVEST" position and secured in place to allow for delivery to the harvesting probe. If the handle is *not* fully turned to the "HARVEST" position, the buffer solution will go directly into your collection flask.

Make certain that the wash pump has been completely primed.

Make certain that if you are using a two-way valve on the black wash pump not to have the valve closed so far as to prevent an adequate amount of delivery into each individual well.

3. After Harvesting

Prior to placing the two metal rods of the harvesting probe into the corresponding holes on the top half of the filter block, pull back on the tygon tubing which is above the filter block. Pulling this tubing toward the back of the Harvester will allow the harvesting probe rests (two metal rods) to fit better and remain seated into the filter block.

Filter Paper for All Harvesters

Harvester	Reeves Angel 934H	Whatman GF/B	Whatman GF/C
For Standard Format Harvesters <i>without</i> Deposit/Dispensing Systems			
12-sample Harvesters	FP-12	FP-101	FP-201
24-sample Harvesters	FP-24	FP-100	FP-200
30-sample Harvesters	FP-30	FP-130	FP-230
36-sample Harvesters	FP-36	FP-136	FP-236
48-sample Harvesters	FP-48	FP-105	FP-205
96-sample Harvesters	FPD-96	FPD-196	FPD-296
For Standard Format Harvesters <i>with</i> Deposit/Dispensing Systems			
12-sample Harvesters	FPD-12	FPD-101	FPD-201
24-sample Harvesters	FPD-24	FPD-100	FPD-200
30-sample Harvesters	FPD-30	FPD-130	FPD-230
36-sample Harvesters	FPD-36	FPD-136	FPD-236
48-sample Harvesters	FPD-48	FPD-105	FPD-205
96-sample Harvesters	FPD-96	FPD-19	FPD-296
For All Counter-Compatible Harvesters			
12-sample, 20ml vials	FP*-12	FP*-112	FP*-212
18-sample, 5 or 7ml vials	FP*-18	FP*-118	FP*-218
24-sample, 20ml vials	FP*-24	FP*-124	FP*-224
30-sample, 20ml vials	FP*-30	FP*-130	FP*-230
36-sample, 5 or 7ml vials	FP*-36	FP*-136	FP*-236
36-sample, 20ml vials	FP*-36L	FP*-136L	FP*-236
48-sample, 5 or 7ml vials	FP*-48	FP*-148	FP*-248
48-sample, 20ml vials	FP*-48L	FP*-148L	FP*-248L
96-sample, 5 or 7ml vials	FP*-96	FP*-196	FP*-296
96-sample, 20ml vials	FP*-96L	FP*-196L	FP*-296L
For All Direct Radioactive Reader Compatibles			
24-sample 4x6 format	FP*R-24	FP*R-124	FP*R-224
48-sample 4x12 format	FP*R-05	FP*R-105	FP*R-205
96-sample 6x16 format	FP*R-96	FP*R-196	FP*R-296
96-sample microtitre	FPX*R-96	FPX*R-196	FPX*R-29

* Please enter the letter that corresponds to your counter or direct reader: **B** Beckman **L** LKB **P** Packard
Others filters available on request

BRANDEL, Inc.
8561 Atlas Drive
Gaithersburg, MD 20850
Telephone: 301-948-6506
Fax: 301-869-5570
E-mail: sales@brandel.com
<http://www.brandel.com>

Filter Paper

Warranty

Biomedical Research and Development Laboratory, Inc. (BRANDEL) guarantees for a period of one year from the original date of shipment, all parts manufactured by it to be free from defects in workmanship and materials. All defective parts will be replaced without charge for parts or labor. BRANDEL will not accept expense or labor incident to the replacement of any part outside of its factory.

Warning

The purchaser assumes all risks in the use and handling of items sold by BRANDEL. BRANDEL is not liable for loss or damage resulting from use or misuse of the products sold by BRANDEL.